



This manual contains safety information that if ignored can endanger life or result in serious injury. They are indicated by this icon.



Keep the instrument protected from sun and water. Avoid water splashes.



OPERATING INSTRUCTIONS FOR WDPHRH / EV / PER / S / TMPER

ERMES COMMUNICATION
www.ermes-server.com

Read Carefully !



ENGLISH Version

R160122



NORME CE
EC RULES(STANDARD EC)
NORMAS DE LA CE

Direttiva Bassa Tensione
Low Voltage Directive
Directiva de baja tensión } 2014/35/UE

Direttiva EMC Compatibilità Elettromagnetica
EMC electromagnetic compatibility directive
EMC directiva de compatibilidad electromagnética } 2014/30/UE



GENERAL SAFETY GUIDELINES

Danger!

In emergencies the pump should be switched off immediately! Disconnect the power cable from the power supply!

When using pump with aggressive chemicals observe the regulations concerning the transport and storage of aggressive fluids!

When installing always observe national regulations!

Manufacturer is not liable for any unauthorized use or misuse of this product that may cause injury, damage to persons or materials.

Caution!

Pump must be accessible at all times for both operating and servicing. Access must not be obstructed in any way!

Feeder should be interlocked with a no-flow protection device.

Pump and accessories must be serviced and repaired by qualified and authorized personnel only!

Always discharge the liquid end before servicing the pump!

Empty and rinse the liquid end before work on a pump which has been used with hazardous or unknown chemicals!

Always read chemical safety datasheet!

Always wear protective clothing when handling hazardous or unknown chemicals! **Missed activation for Min/Max alarm and Maximum Dosing Alarm may cause hazardous overdosing!**

WARNING

IF EQUIPMENT IS NOT SUPPLIED WITH A PLUG:



- a) a switch or circuit-breaker shall be included in the building installation
- b) it shall be in close proximity to the equipment and within easy reach of the operator
- c) it shall be marked as the disconnecting device for the equipment

1. Introduction

WDPHRH is a fully Integrated All-in-One Swimming Pool Controller. Ideal for new construction projects the WDPHRH innovates panel mount capability into a small wall-mount package. For WDPHTMPER version see page 39. 2 Pumps for ORP and pH adjustment in PVDF, small-form-factor saves space, installation time, and shipping expense. It includes Input for a Flow Switch. Integral pumps can handle up to 20 bar and 16 l/h (Self-Venting Liquid-end as option), high maintenance tubing sets and roller assemblies.

Working ranges are: pH : from 0 to 14pH
 ORP: from 0 to 999 mV

Please note about background color display (RGB Version only):

GREEN: normal working mode | **WHITE :** Standby | **RED:** Alarm (che info status)

YELLOW: Warning (check controller, ie.: delay time active)

All information are provided through a large LCD display. Using a revolutionary wheel control the instrument can be easily programmed. WDPHRH is housed in a IP65 plastic box (IP 54 peristaltic pump model).

2. The wheel

Located in the upper right side of WDPHRH there is a wheel that must be used to control the instrument. Wheel can be rotated in both directions to scroll over the menus and / or pressed to confirm highlighted selection / value.

NOTE: Once changes are made press "OK" to save and exit from submenu. Press "ESC" to exit without saving.

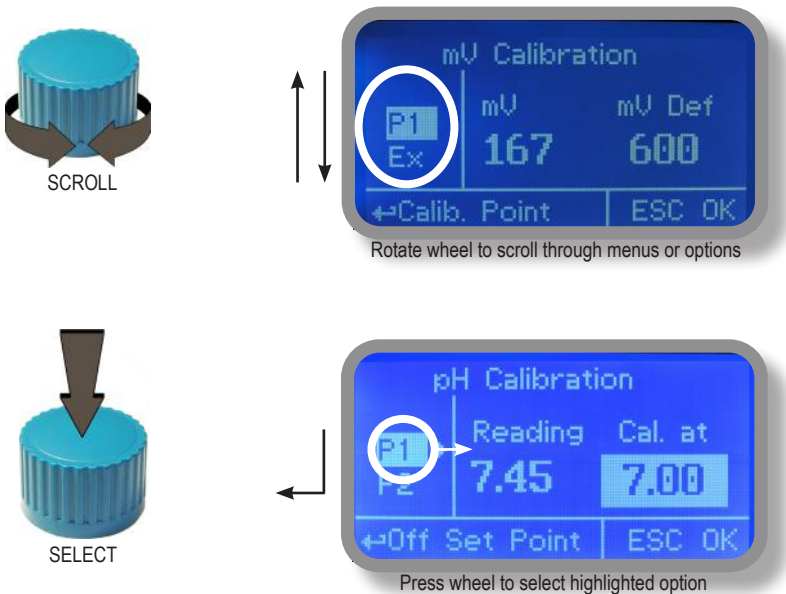

3. Mainboard Connections



Unplug instrument from main power supply then perform connections to probes and / or selected outputs by following the below picture.

WARNING:
Access to live voltage parts!

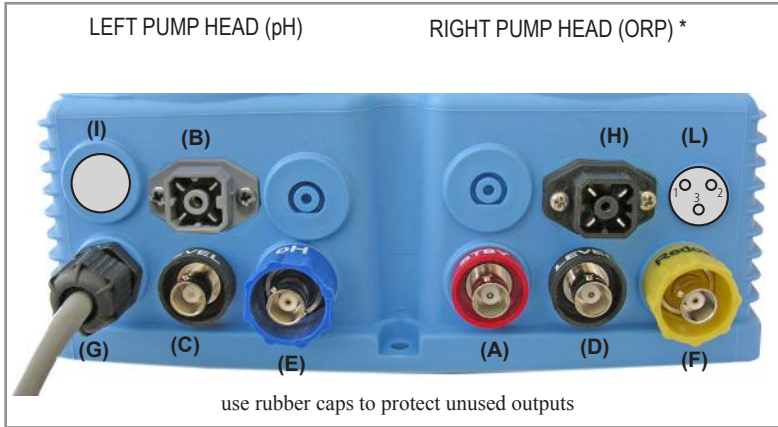

Warning: Connections must be performed by qualified and trained personnel only.

If the supply cord is damaged, it shall be replaced by the manufacturer or its service agent or similarly qualified person in order to avoid a hazard.

(A) STAND-BY input

(L) RS485 communication / MODBUS / WiFi

(B) FLOW input*****



- 1 Blue (ground)
- 2 Brown (+)
- 3 n/a
- 4 Black (Signal)

*****NPED4 contact version: pin 2 and 4

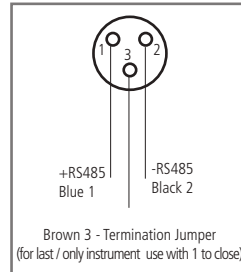

(C) pH Level input (left pump head)

(D) ORP Level input (right pump head)

(E) pH EPHS probe connector

(F) ORP ERHS probe connector

(G) Power Supply: 230VAC 50-60 Hz. or 115VAC** or 24 VAC or VDC**

(H) Alarm contact output*****:



- 1 n/a
- 2 Black
- 3 Red
- 4 n/a

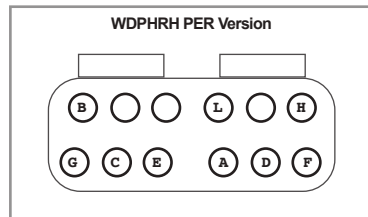

(I) Electrovalve output 230VAC 50-60 Hz (WDPHRH EV*** version only) or 115VAC** or 24 VAC** or pH and ORP level alarm output (pH yellow and white wires, ORP brown and green wires)

*230VAC output for WDPHRHS model only ** (see instrument's label) ***three point EV: white/neutral - brown/phase (close) - green/phase (open) *****freecontact max load 4A 250V (active when flow alarm, level, dosing problem and broken probe)

3.1 Hydraulic connections, hoses

Unplug instrument from main power supply then perform connections to probes and / or selected outputs by following the above picture. Hydraulic connections are:

Suction Hose with level probe and foot filter
Delivery Hose with injection valve
Discharge Hose

Suction Hose.

Completely unscrew tightening nut from pump's head and remove assembling components: tightening nut, holding ring and pipe holder.

Assembly as shown. Insert hose into pipe holder until it reaches the bottom.

Lock hose on pump's head by screwing down the tightening nut.
Use only hands to do it!

Connect other side of the hose to the foot filter using the same procedure.

Delivery Hose.

Completely unscrew tightening nut from pump's head and remove assembling components: tightening nut, holding ring and pipe holder.

Assembly as shown. Insert hose into pipe holder until it reaches the bottom.

Lock hose on pump's head by screwing down the tightening nut.
Use only hands to do it!

Connect other side of the hose to the injection valve using the same procedure.

Discharge hose.

Insert one side of discharge hose into pump head discharge connector.

Insert other side of discharge hose into product's tank.
During priming procedure product exceeding will flow into tank.

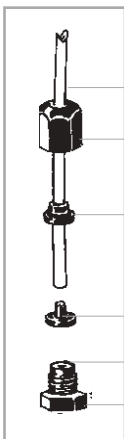

Suction Hose

Tightening Nut

Holding Ring

Pipe Holder

O-ring

Valve

3.2 Hydraulic connections, level probes

Assembling foot filter with level probe. Level probe must be assembled with foot filter using the provided kit. Foot valve is made to be installed into tank's bottom without sediments priming problem.

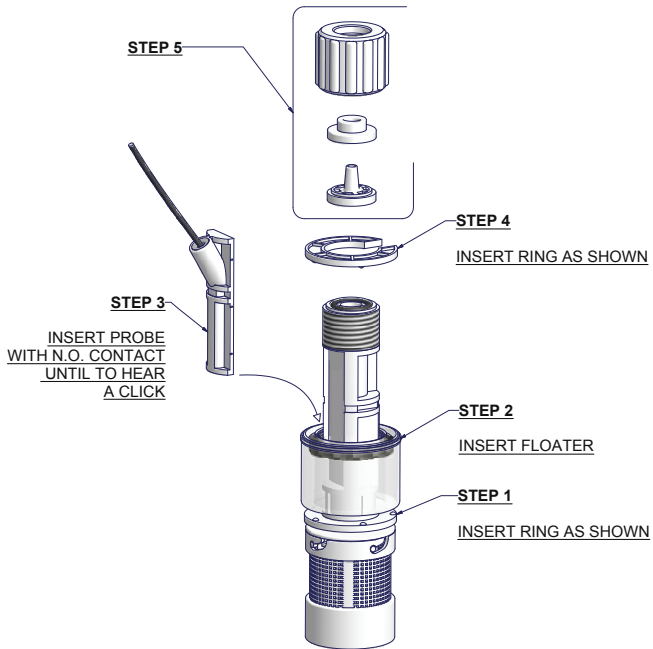

Connect BNC from level probe into WDPHRH level inputs ("B" and "E" connectors).

Put level probe assembled with foot filter into tank's bottom.

Warning: If there is a mixer installed into tank, install a suction lance instead of level probe / foot filter.



WARNING
IF EQUIPMENT IS SUPPLIED WITH A PLUG:

If an appliance coupler or separable plug is used as the disconnecting device, it shall be readily identifiable and easily reached by the operator. For single-phase portable equipment, a plug on a cord of length not greater than 3m is considered to be easily reached.



WARNING
IF EQUIPMENT IS NOT SUPPLIED WITH A PLUG:

- a) a switch or circuit-breaker shall be included in the building installation
- b) it shall be in close proximity to the equipment and within easy reach of the operator
- c) it shall be marked as the disconnecting device for the equipment

3.3 Hydraulic connections, pump heads

Injection Valve.

Injection valve must be installed on plant from water's input.
Injection valve will open at pressure greater than 0,3bar.

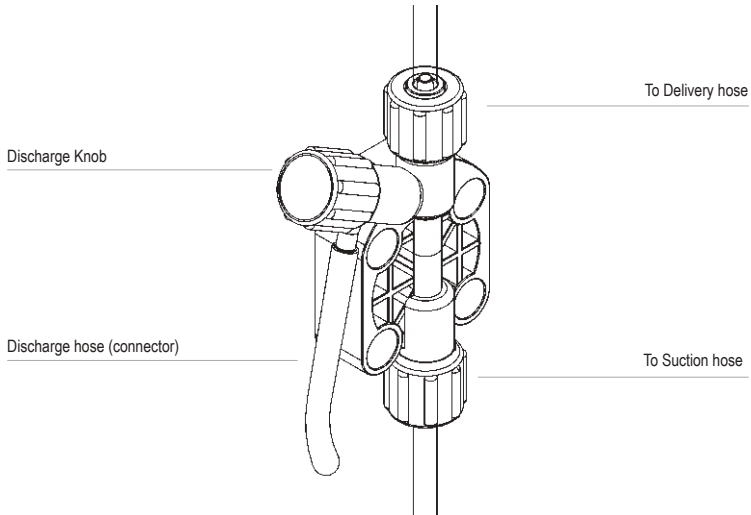

Feeder should be interlocked with a no-flow protection device to automatically shut-off the pumps when there is no flow!

Adequate measures shall be taken to prevent cross connection of chemicals!

Chemical feeding must be stopped during backwash cycles and periods of noflow as these conditions may introduce the potential for chemical overdosing. Not doing so may result in elevated chemical concentrations and hazardous gas introduction into the pool or spa.

3.4 WDPHRH PER Version (Flow: 2,2 l / h)

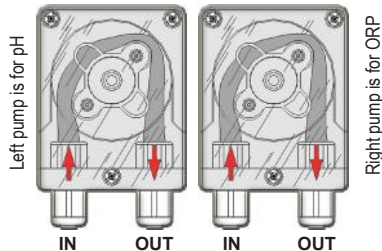

4. Main Screen

When into normal operating mode, WDPHRH shows the following main screen:

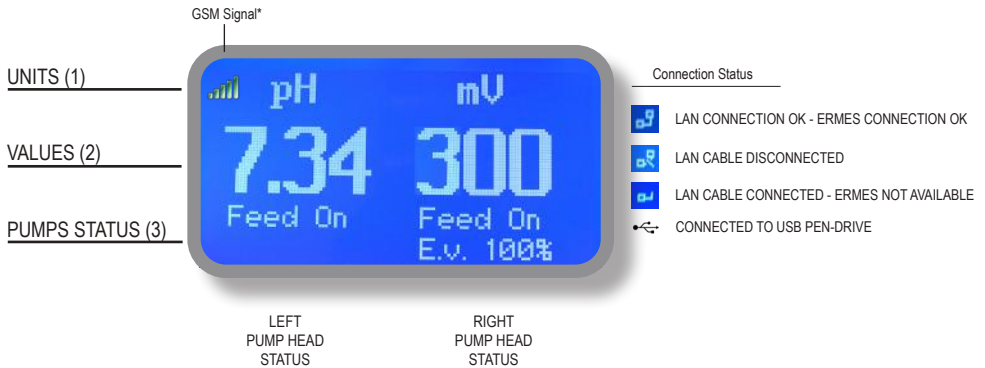

Main screen is divided into 3 zones.

- (1) UNITS. "pH" is the measuring unit for pH probe.
"mV" is the measuring unit for ORP probe.
- (2) VALUES. These numbers are values read by the probes.
- (3) PUMPS STATUS. These fields are related to current pumps status and instrument activity.
E.V. Status (WDPHRH EV model)

DISPLAY	EXPLANATION	WHAT TO DO IF OCCURS
FEED ON	Pump is dosing chemical product.	No action required.
FEED OFF	Pump is OFF.	No action required.
LOW TANK	Chemical product tank is almost empty.	Check chemical tank. Restore correct level.
NO FLOW	External flow contact stops both the pumps.	Check flow.
OK	Setpoint reached.	No action required.
FEED LIMIT	Time for dosing exceeded. Dosing alarm.	Check pump dosing capacity.
PROBE FAIL	Stuck reading values.	Check probe for proper functioning.
DELAY	Pump activity delayed. Countdown in progress.	If not requested check PARAMETERS options.
WAIT PH	pH priority dosage over ORP dosage.	If not requested check PRIORITY options.
POWER SUPPLY OUT OF RANGE	Power supply is out of range. F2 fuse on connection board can be broken.	Check power supply range. Replace F2 fuse (p. 30)

5. Quick status check

From main screen rotate the wheel to review main instrument parameters and current status conditions.

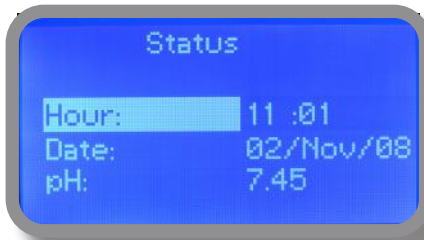

Current time
Today date
Current pH reading



Current ORP reading
Dosing alarm condition
Probe failure status
NO FLOW contact status

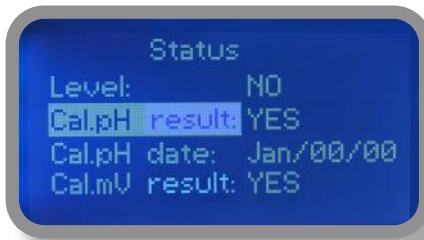

Tank Level status
Last pH calibration result
Last pH calibration date
Last ORP calibration result

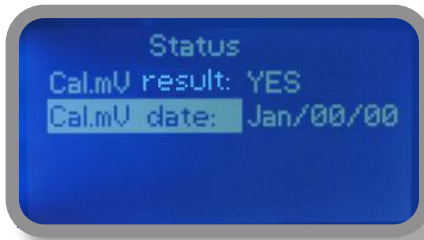

Last ORP calibration date

6. Password

To grant access into "Main Menu" press the wheel from main screen and enter the passcode.

If this is the first time here then the passcode is 0000 (factory preset). Press wheel 5 times to enter into "Main Menu".

Otherwise press the wheel 1 time and enter the passcode. Numbers can be selected rotating the wheel.

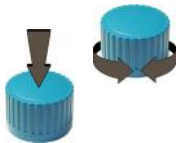
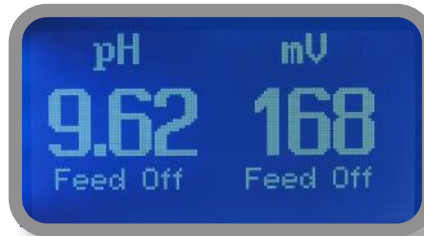

To set a new passcode choose "PARAMETERS" from "Main Menu", move on "New Pcode", Or click on wheel and enter a four numbers code. Or click on "EXIT" and choose "YES" to save request. The new passcode is now ready.

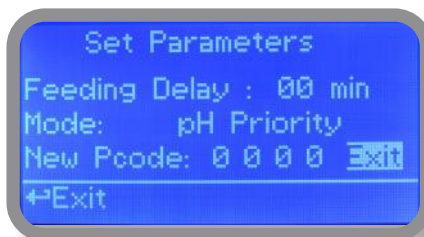
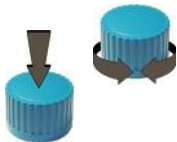









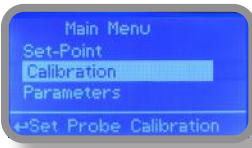

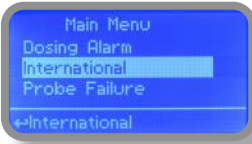

Lost passcode ?

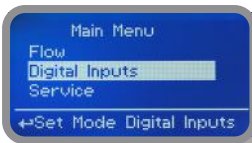
Please don't forget the passcode (if changed). In the unfortunate event, please call your local distributor for unlocking procedure. There is no way for you to recover lost passcode.

7. “Main Menu” list

To grant access into “Main Menu” enter the passcode (as described in previous chapter). Once into “Main Menu” rotate the wheel to scroll through all the options available.

		<p>“Set-Point” (see page 12) “Calibration” (see page 19) “Parameters” (see page 22)</p>
		<p>“Pumps Activities” (see page 23) “Instrument Reset” (see page 24) “Max Strokes Settings” (see page 24)</p>
		<p>“Dosing Alarm” (see page 25) “International” (see page 26) “Probe Failure” (see page 27)</p>
		<p>“Flow” (see page 28) “Digital Inputs” (see page 29) “Service” (see page 28)</p>
		<p>Log Setup” (see page 30) “RS485 Setup” (see page 31) “SMS menu” (see page 31)</p>
		<p>TCP IP (see page 32) GPRS (see page 33) Email (see page 33)</p>
		<p>Log View (see page 30) Modbus (see page 29) WiFi (optional, see page 37)</p>

8. "Set-Point", pH (on/off)

pH reading values can be set to operate the pH pump using 2 set-points into **On/Off mode** or **Proportional (%)**.

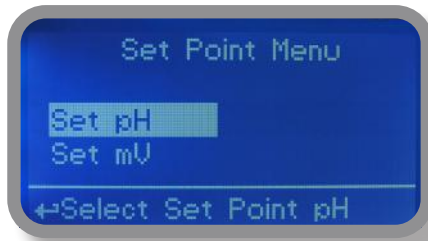

On/Off mode set the instrument to operate using two set values that enable or disable the pH pump. To use this mode move cursor on "Working Mode". Press the wheel and select it.

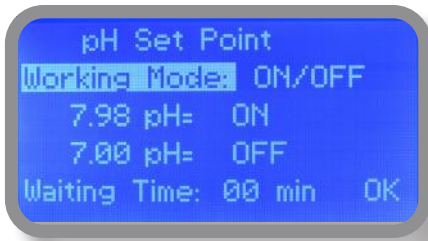
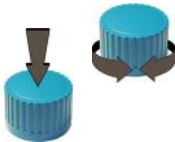

ON/OFF mode while dosing ALKALI

Set pH value at 7.00 OFF and 6.90 ON.

Instrument will leave the pH pump active until reading value will increase up to 7.00pH.

At 7.00pH the pH pump will be disabled until reading value will decrease under 6.90pH.

Waiting Time: to let pump operate at pulses per minutes add one or more minute (1pulse every xx minutes). Otherwise (00 minutes) pump will operate at set stroke settings (see page 22).

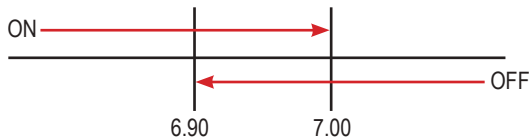

8. "Set-Point", pH (on/off)

ON/OFF mode while dosing ACID

Set pH value at 7.00 OFF and 7.10 ON.

Instrument will leave the pH pump active until reading value will decrease up to 7.00pH

At 7.00pH the pH pump will be disabled until reading value will increase up to 7.10pH.

Waiting Time: to let pump operate at pulses per minutes add one or more minute (1pulse every xx minutes). Otherwise (00 minutes) pump will operate at set stroke settings (see page 22).

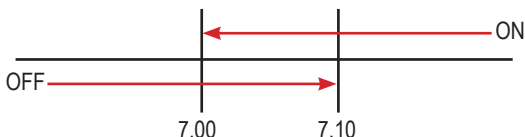

Do you know ?

In chemistry, an alkali is a basic, ionic salt of an alkali metal or alkaline earth metal element. Alkalis are best known for being bases (compounds with pH greater than 7) that dissolve in water. The adjective alkaline is commonly used in English as a synonym for base, especially for soluble bases. This broad use of the term is likely to have come about because alkalis were the first bases known to obey the Arrhenius definition of a base and are still among the more common bases. Since Brønsted-Lowry acid-base theory, the term alkali in chemistry is normally restricted to those salts containing alkali and alkaline earth metal elements.

An acid (often represented by the generic formula HA [H+A-]) is traditionally considered any chemical compound that, when dissolved in water, gives a solution with a hydrogen ion activity greater than in pure water, i.e. a pH less than 7.0. That approximates the modern definition of Johannes Nicolaus Brønsted and Martin Lowry, who independently defined an acid as a compound which donates a hydrogen ion (H+) to another compound (called a base). Common examples include acetic acid (in vinegar) and sulfuric acid (used in car batteries). Acid/base systems are different from redox reactions in that there is no change in oxidation state.

8.1 "Set-Point", pH (proportional)

pH reading values can be set to operate the pH pump using 2 set-points into **On/Off mode** or **Proportional (%)**.



Proportional mode set the instrument to operate using a calculated percentage between two set values that enable or disable the pH pump. To use this mode move cursor on "Working Mode". Press the wheel and select it.



PROPORTIONAL mode between 7pH(0%) and 8pH (100%). [Stroke setting 180]

In this mode the pH pump will be "ON" for values greater than 8pH with maximum set strokes capacity (e.g.: 180) and it'll be "OFF" for values lower than 7pH. For values of 7.5pH pump will be "ON" with 90 strokes capacity. The calculation is based on 180 strokes setting (see page 22).

8.2 "Set-Point", ORP (on/off)*

ORP reading values can be set to operate the ORP pump using 2 set-points into **On/Off mode** or **Proportional (%)**.



On/Off mode set the instrument to operate using two set values that enable or disable the ORP pump. To use this mode move cursor on "Working Mode". Press the wheel and select it.



ON/OFF mode

Set ORP value at 600mV ON and 700mV OFF. The difference between the two ORP values is called **HYSTERESIS**. Instrument will enable the ORP pump when reading value will decrease at 600mV. At 600mV the ORP pump will be enabled until reading value will increase at 700mV.

Waiting Time: to let pump operate at pulses per minutes add one or more minute (1pulse every xx minutes). Otherwise (00 minutes) pump will operate at set stroke settings (see page 22).

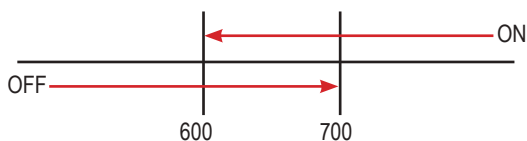

*230VAC output for WDPHRHS model only

8.3 “Set-Point”, ORP (proportional)*

ORP reading values can be set to operate the pH pump using 2 set-points into **On/Off mode** or **Proportional (%)**.



Proportional mode set the instrument to operate using a calculated percentage between two set values that enable or disable the ORP pump. To use this mode move cursor on “Working Mode”. Press the wheel and select it.



PROPORTIONAL mode between 700mV (0%) and 600mV (100%). [Stroke setting 180]

In this mode the ORP pump will be “ON” for values lower than 600mV with maximum set strokes capacity (e.g.: 180) and it’ll be “OFF” for values greater than 1mg/l. For values of 650mV pump will be “ON” with 90 strokes capacity. The calculation is based on 180 strokes setting (see page 22). To end procedure move cursor on “OK” and press wheel to proceed to “Save” request screen. Move wheel on “YES” to save or “NO” to discard changes.

*230VAC output for WDPHRHS model only

8.4 "Set-Point", EV (on/off) - mod. "WDPHRH EV"

ORP reading values can be set to operate the EV output using 2 set-points into **On/Off mode** or **Proportional (%)**.



On/Off mode set the instrument to operate using two set values that enable or disable the EV Output. To use this mode move cursor on "Working Mode". Press the wheel and select it.



ON/OFF mode

Set ORP value at 600mV ON and 700mV OFF. The difference between the two ORP values is called **HYSTERESIS**.

Instrument will enable the EV output when reading value will decrease at 600mV

At 600mV the EV output will be enabled until reading value will increase at 700mV.

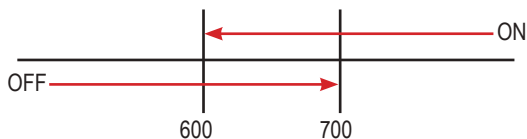

8.5 “Set-Point”, EV (proportional) - mod. “WDPHRH EV”

ORP reading values can be set to operate the pH pump using 2 set-points into **On/Off mode** or **Proportional (%)**.



Proportional mode set the instrument to operate using a calculated percentage between two set values that enable or disable the EV output. To use this mode move cursor on “Working Mode”. Press the wheel and select it.



PROPORTIONAL MODE between 700mV (0%) and 600mV(100%) based on 100 seconds time.
EV output will be on for lower than 600mV values and off for higher than 700mV with activity based on 100 seconds

9. "Probe Calibration", pH

pH calibration procedure involves two calibration points and it requires two buffer solutions. Default buffer solutions are pH 4.00 and pH 7.00. From "Menu Calibration" choose "pH probe".



In the following example instrument will calibrate pH using default buffer solutions values.

Note: this procedure assumes that instrument is correctly configured and a working pH probe connected. Otherwise unattended results may occur.

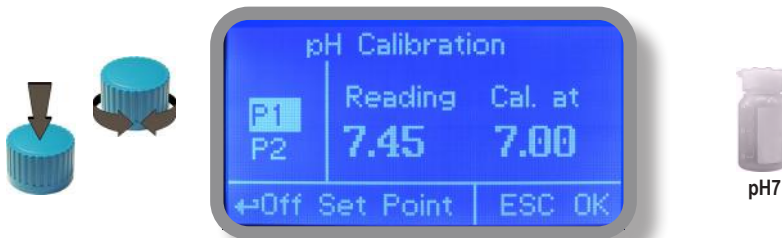

Calib 1st Point.

Once into "pH Calibration" menu move wheel on "P1" then press wheel to enter into first point calibration submenu. Prepare 7.00pH buffer solution and dip probe's sensor on it. Wait until reading value is stable and according to buffer solution value move wheel until it is the same on display ("Cal. at" field). Default value is 7.00pH.

Note: buffer solution value may change if environment temperature it's different than 20°C. Read solution's label for more information. According to this occurrence "pH Default" must be changed.

9. "Probe Calibration", pH

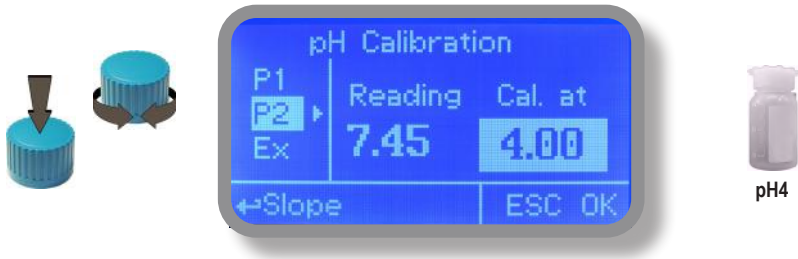

Calib 2nd Point.

Move wheel on "P2" then press wheel to enter into second point calibration submenu. Prepare 4.00pH buffer solution and dip probe's sensor on it. Wait until reading value is stable and according to buffer solution value move wheel until it is the same on display ("Cal. at" field). Default value is 4.00pH.

Note: buffer solution value may change if environment temperature it's different than 20°C. Read solution's label for more information. According to this occurrence "pH Default" must be changed.

9.1 "Probe Calibration", ORP

ORP calibration procedure involves probe's selection with one point (P1) calibration. From "Menu Calibration" choose "ORP probe".



Note: This procedure assumes that instrument is correctly configured and a working ORP probe connected and installed on system. Measurement must be performed using plant water. Otherwise unattended results may occur.

Calibration can be performed in two ways: the first by alignment with a buffer solution, the second by reading the residual chlorine level of the pool with the DPD1, comparison with the attached graph followed by alignment of the pumps group. The choice of method is exclusively at the user's discretion. In both cases, to establish the set-point value, a check using the DPD1 or other analysis system is necessary. The enclosed graphs provide a reference between the mV value read by the pumps group and the quantity of residual chlorine expressed in mg/litre, and are linked to the pH value.

- 1) Measure buffer solution temperature and verify that it is the same printed on solution's label.
- 2) Remove protective cap from probe and wash probe's tip into water. Then dry it by shaking the probe in air.
- 3) On WDPHRH set "mV Def" value to match buffer solution value then put probe's tip into buffer solution and wait until WDPHRH shows a stable reading value (mV field).
- 4) Move cursor on "OK" and press wheel to confirm the new calibration value. If calibration process fails the instrument will show "CALIBRATION FAILED". Repeat procedure otherwise move on "ESC" and press wheel.

REDOX - mg FREE CHLORINE - pH GRAPHIC TABLE

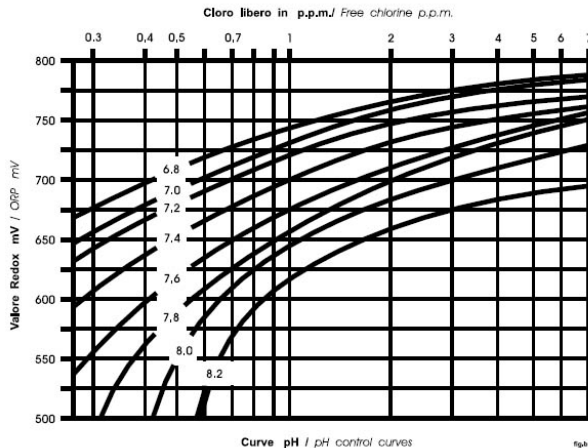

10. "Parameters"

From "Menu Calibration" choose "Parameters". This menu allows to set a delay (max 60 minutes) before pumps begin to feed. Furthermore use this menu to set pH pump startup priority and to change default passcode.



TAU (if available)

If probe reading values change very quickly it is possible to increase TAU value to stabilize them. Standard value is: 05. The maximum value is: 30.

Feeding Delay.

Move on "Feeding Delay" then press wheel. Choose a value between 0 (disabled) and 60 minutes (maximum delay time). This feature can be used to accord a startup delay for the pumps. Delay occurs when instrument is powered or after a "NO FLOW" contact recovery.

Mode.

Move on "Mode" then press wheel. If both pumps need to operate, a startup priority can be set to allow the pH pump to begin to feed prior to ORP pump. Choose "pH priority" to enable this function. ORP pump will begin to dose when pH pump has stopped.

New Pcode.

See page 10.

To end procedure move cursor on "OK" and press wheel to proceed to "Save" request screen. Move wheel on "YES" to save or "NO" to discard changes.

11. "Pumps Activities"

From "Menu Calibration" choose "Pumps activities". This menu allows to manually operate one or both the pumps for a settable time.

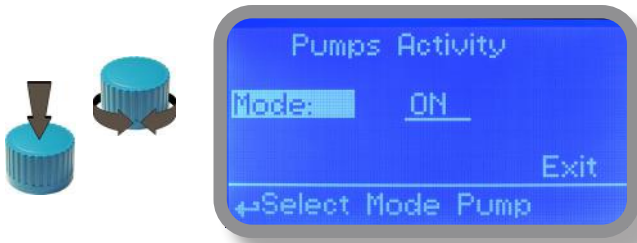

Move on "Mode" then press wheel. Choose "Man. Pump1" for manually operate pH pumps or "Man. Pump2" for ORP pump.

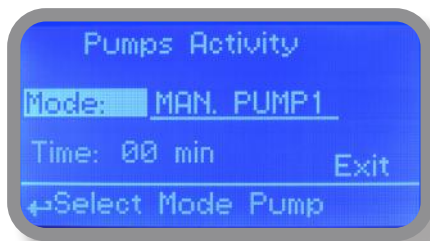

Press wheel to move cursor on "TIME" field. Once here, choose a working time between 0 (disabled) or 199 minutes. Move on "EXIT", then press wheel.

Exit from main menu. Main display will show a countdown including the selected pump (left for pH pump, right for ORP pump). To stop this countdown go back to "Pump activities" menu and choose "ON" as working mode or wait until countdown ends. **This function can be used for priming purposes.**

11. "Instrument Reset"

To restore instrument to its default values (including password) once into "Instrument Reset" menu, press wheel then change value to "ON", press wheel again, move on "OK" then finally press wheel. The instrument display will show "CHECKSUM ERROR". Press wheel to return into "Main Menu". Move on "EXIT", then press wheel. The instrument is now restored to factory default. Please repeat all calibration procedures and programming parameters.



12. "Max strokes settings"

pH and ORP pumps can be set to operate within a maximum number of strokes. Strokes are the total amount of injections per minute made by a pump. Using wheel choose a value for one or both pumps then move on "EXIT". To end procedure move cursor on "OK" and press wheel to proceed to "Save" request screen. Move wheel on "YES" to save or "NO" to discard changes.



Note: Pumps dosing capacity is based on 180 strokes per minutes

13. "Dosing Alarm"

Use this menu to assign a maximum time to the pumps for reaching the setpoint. If set time ends and the pumps are still dosing, within this menu is possible to STOP them or just to show an alarm message. Function can be disabled selecting "OFF" instead of a number (minutes). Dosing alarm can be set for both or just one pump.

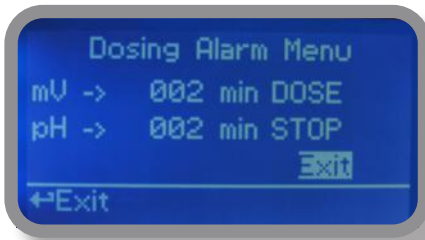

E.g. To set ORP pump to stop after time ends and setpoint isn't still reached press wheel, choose maximum time, press wheel move on next field and choose "STOP". Time can be set between 0 and 100 minutes. When satisfied with settings move on exit and press wheel.

14. "International"

Use this menu to set international parameters as UNIT FORMAT (Europe IS or USA), Local Time and Date.

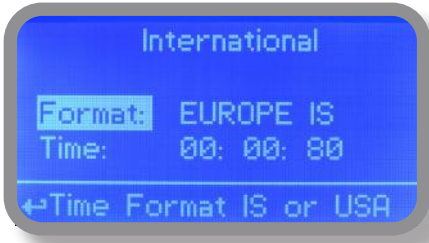

Format.

Use this option to use European or USA units format. See table for differences.

EUROPE IS (International Standard)	USA
Date (DD/MMM/YY)	Date (MMM/DD/YY)
Time 24h	Time AM / PM

Time.

Use this option to set local time.

Date.

Use this option to set date.

Move on exit to end changes.

15. "Probe Failure"

Use this menu to assign a maximum time to connected probes to stay stuck. A stuck probe (it remains on same value for some time) means that probably probe itself is damaged. Within this menu is possible to STOP pumps or just to show an alarm message (probe failure) . Function can be disabled selecting "OFF" instead of a number (minutes). This function can be set for both or just one probe.

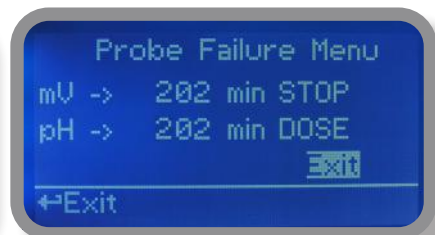
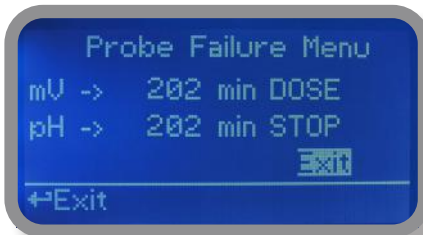

E.g. To set ORP pump to stop after time ends and probe doesn't change reading values press wheel, choose maximum time, press wheel move on next field and choose "STOP". Time can be set between 100 and 254 minutes. When satisfied with settings move on exit and press wheel.

16. "Flow Contact"

Flow contact (locate connection on page 4) can be enabled to stop all dosing activities using a DIRECT contact (N.O. normally opened contact) or REVERSE contact (N.C. normally closed contact). Move wheel for enabling and changing contact logic (DIRECT or REVERSE). Furthermore "Flow contact" can start after a specified time when contact status changes. To set it move wheel on "Time:00 min", click it and rotate to choose time (from 0 to 99 minutes). Confirm selection by clicking wheel.

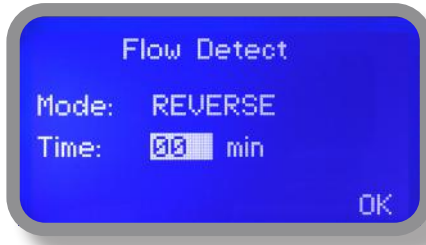
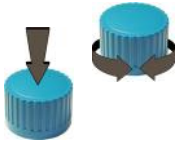

17. "Service"

This "view only" menu shows probes reading live. Press "ESC" to exit.



18. "Digital Inputs" - Contact mode for inputs

This function sets contact type for each digital input. Contact type can be set as N.O. (normally open contact) or N.C. (normally closed contact). Using the wheel move on required input, press wheel then rotate the wheel to choose between N.O. or N.C.



WDPHRH EV: For Level mV input only is possible to leave EV output on (DOSE) or off (STOP) when a ORP level alarm occurs.

To end procedure move cursor on "OK" and press wheel to proceed to "Save" request screen. Move wheel on "YES" to save or "NO" to discard changes.

18.1 MODBUS

Modbus is a serial communications protocol originally published by Modicon (now Schneider Electric) in 1979 for use with its programmable logic controllers (PLCs). Simple and robust, it has since become a de facto standard communication protocol, and it is now a commonly available means of connecting industrial electronic devices.

From main menu select COMMUNICATION then MODBUS to access the options. Set the communication speed according to the PLC system available. Set the ID assigning an UNIQUE address to avoid conflicts.

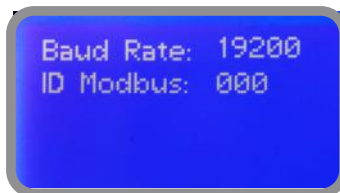

19. "LOG SETUP" - Activities log setup

This function records instrument activity (date, hour, temperature, uS, totalizer I/O, alarms, outputs). It starts for selected frequency period (every) at requested time (time).

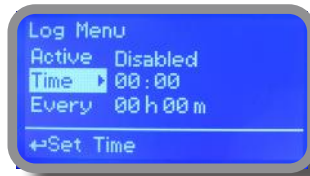

Set ACTIVE to "enabled" to activate log recording.

TIME: recording start time (time format 23h e 59min)

EVERY: recording frequency (time format 23h e 59min)

Note: advanced log control (graph, printing, comparison tables, event filtering, etc) is available through "ERMES Communication Software" for PC.

See "ERMES Communication Software" manual for proper PC software configuration.

20. "LOG VIEW" - Activities log viewer

To see alarm log entries as set on log menu choose "log view" on main menu.



SET DATE & TIME BEFORE TO ENABLE LOG. IF NOT POWERED FOR ABOUT 30 DAYS THE INSTRUMENT WILL LOOSE DATE/TIME

21. "RS485" - Communication port setup

Prior to install the instrument into an RS485 local system a unique ID NUMBER (from 1 to 30) and ID NAME (station name) must be set. Rotate wheel and edit fields. If ID number has already assigned an error message will follow after ID Check (move cursor on CHECK and press wheel). In this event try using another number.

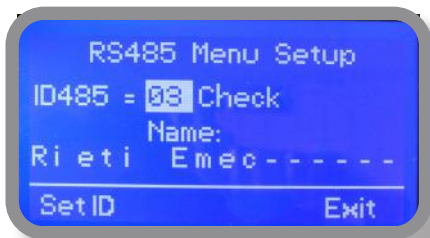

22. "SMS Menu"

Instrument may remotely send SMS alarm messages using its own modem (sold as option). It can be configured as follows:

SMS1 / SMS2 /SMS3.

Using the wheel enter a mobile phone that will receive alert SMS messages if something wrong occurs. SMS number must be set using local number format. For example : 3391349134 will send an SMS message to mobile phone. Log level (and SMS frequency alert) may be set using options in "ACTIVE MSG" within "GSM menu".



- TO AVOID UNDESIRED MESSAGES USE CAREFULLY LOG SETUP -

- WARNING: THIS FUNCTION COULD NOT BE FREE OF CHARGE. DEPENDING ON YOUR OPERATOR CONTRACT IT COULD GENERATE PAYING SMS TRAFFIC !

23. "TCP/IP" - LAN setup

The instrument may be remotely operated using a standard ethernet connection (sold as option). A static or dynamic IP address and a CAT5 ethernet cable is required. According to your network capacity connection speed is 10/100Mbps. To obtain a valid IP address and subnet mask contact your net administrator. Enter parameters and move cursor on "SAVE" to store parameters then move on "OK" and press wheel to save and activate configuration.

Based on your network configuration choose to obtain network parameters automatically (DYNAMIC) or manually (STATIC).



See "ERMES Communication Software" manual for proper PC software configuration.

What is a static IP address/dynamic IP address?

A static IP address is a number (in the form of a dotted quad) that is assigned to a computer by an Internet service provider (ISP) to be its permanent address on the Internet. Computers use IP addresses to locate and talk to each other on the Internet, much the same way people use phone numbers to locate and talk to one another on the telephone. When you want to visit whatis.com, your computer asks a domain name system (DNS) server (think telephone information operator) for the correct dotted quad number (think phone number) for whatis.com and your computer uses the answer it receives to connect to the whatis.com server. It would be simple if every computer that connects to the Internet could have its own static IP number, but when the Internet was first conceived, the architects didn't foresee the need for an unlimited number of IP addresses. Consequently, there are not enough IP numbers to go around. To get around that problem, many Internet service providers limit the number of static IP addresses they allocate, and economize on the remaining number of IP addresses they possess by temporarily assigning an IP address to a requesting Dynamic Host Configuration Protocol (DHCP) computer from a pool of IP addresses. The temporary IP address is called a dynamic IP address.

Requesting DHCP computers receive a dynamic IP address (think temporary phone number) for the duration of that Internet session or for some other specified amount of time. Once the user disconnects from the Internet, their dynamic IP address goes back into the IP address pool so it can be assigned to another user. Even if the user reconnects immediately, odds are they will not be assigned the same IP address from the pool. To keep our telephone analogy going, using a dynamic IP address is similar to using a pay phone. Unless there is a reason to receive a call, the user does not care what number he or she is calling from.

There are times, however, when users who connect to the Internet using dynamic IP wish to allow other computers to locate them. Perhaps they want to use CU-SeeMe or use a VoIP application to make long distance phone calls using their IP connection. In that case, they would need a static IP address. The user has two choices; they can contact their ISP and request a static IP address, or they can use a dynamic DNS service. Either choice will probably involve an additional monthly fee.

Using a dynamic DNS service works as if there was an old-fashioned telephone message service at your computer's disposal. When a user registers with a DNS service and connects to the Internet with a dynamic IP address, the user's computer contacts the DNS service and lets them know what IP address it has been assigned from the pool; the service works with the DNS server to forward the correct address to the requesting DHCP computer. (Think of calling the message service and saying "Hi. I can be reached at 435.44.32.111 right now. Please tell anyone who tries to reach me to call that number.") Using a dynamic DNS service to arrange for computers to find you even though you are using a dynamic IP address is the next-best thing to having a static IP.

Communication - Software

24. “GPRS” menu.

Instrument may be remotely operated using an embedded standard GPRS modem (sold as option). In order to activate this service please ensure that the following steps are correctly completed:

- Make certain the antenna location is not shielded by metal objects or near sources of electrical 'noise'.
- Make certain the distance from the antenna to the “Instrument” unit is within cable length.
- Do not route the cable where it could be pinched in doors, windows etc.
- Ensure that SIM into “Instrument” modem is correctly inserted, activated and within operator range.

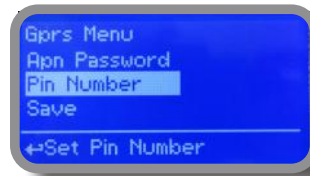
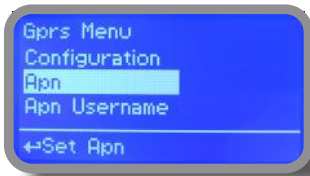

Instrument can be set for automatic configuration (Configuration option set to “Automatic”) or manually (Configuration option set to “Manual”) based on your SIM data access parameters. For manual configuration option enter APN (access point name) and SIM phone number. Move wheel on “OK” to save and move on “ESC” to go back to main menu.

Don't forget to enter SIM CODE into PIN NUMBER menu to unlock SIM.

WARNING: THIS FUNCTION COULD NOT BE FREE OF CHARGE. DEPENDING ON YOUR OPERATOR CONTRACT IT COULD GENERATE PAYING DATA TRAFFIC !

25. “Email” menu.

If Ethernet module or GPRS module is installed (sold as option) the instrument can be configured to send email alarm messages up to two recipients. Click on “Email 1” or “Email 2” and enter email address.

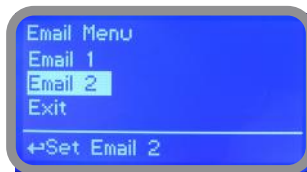

Access point name (APN) identifies an IP packet data network (PDN), that a mobile data user wants to communicate with. In addition to identifying a PDN, an APN may also be used to define the type of service, (eg connection to wireless application protocol (WAP) server, multimedia messaging service (MMS)), that is provided by the PDN. APN is used in 3GPP data access networks, eg general packet radio service (GPRS), evolved packet core (EPC).

26. Technical information.

Power supply: 230 VAC (190÷265 VAC) or 115VAC** or 24 VAC**

pH range: 0 ÷ 14 ; ORP range: 0÷999 mV

Pump Strokes: 0 ÷ 180

Suction Height: 1,5 metres

Environment Temperature: -10 ÷ 45°C (14 ÷ 113°F)

Chemical Temperature: 0 ÷ 50°C (32 ÷ 122°F)

Installation class: II

Pollution Level: 2

Audible Noise (single head): 74dbA

Packaging and Transporting Temperature: -10 ÷ 50°C (14 ÷ 122°F)

Protection degree: IP 65 (IP54 peristaltic pump model)

** (see instrument's label)

Recommended Chemicals Table		
Chemical Product	Formula	Maximum % Concentration
Hydrochloric Acid	HCl	33%
Sulphuric Acid	H ₂ SO ₄	96%
Sodium Bisulphate	NaHSO ₄	37%
Sodium Chlorite	Na ClO ₂	30%
Sodium Hypochlorite	Na OCl	13,5%
Calcium Hypochlorite	Ca (ClO) ₂	2%
Dichloroisocyanuric Sodium	(CON) ₂ Cl Na	4%
Alluminium Sulphate	Al ₂ (SO ₄) ₃	16%
Ferric Chloride	Fe Cl ₃	40%

Product	Formula	Ceram.	PVDF	PP	PVC	SS 316	PMMA	Hastel.	PTFE	FPM	EPDM	NBR	PE
Acetic Acid, Max 75%	CH ₃ COOH	2	1	1	1	1	3	1	1	3	1	3	1
Hydrochloric Acid, Concentrate	HCl	1	1	1	1	3	1	1	1	1	3	3	1
Hydrofluoric Acid 40%	H ₂ F ₂	3	1	3	2	3	3	2	1	1	3	3	1
Phosphoric Acid, 50%	H ₃ PO ₄	1	1	1	1	2	1	1	1	1	1	3	1
Nitric Acid, 65%	HNO ₃	1	1	2	3	2	3	1	1	1	3	3	2
Sulphuric Acid, 85%	H ₂ SO ₄	1	1	1	1	2	3	1	1	1	3	3	1
Sulphuric Acid, 98.5%	H ₂ SO ₄	1	1	3	3	3	3	1	1	1	3	3	3
Amines	R-NH ₂	1	2	1	3	1	-	1	1	3	2	3	1
Sodium Bisulphite	NaHSO ₃	1	1	1	1	2	1	1	1	1	1	1	1
Sodium Carbonate (Soda)	Na ₂ CO ₃	2	1	1	1	1	1	1	1	2	1	1	1
Ferric Chloride	FeCl ₃	1	1	1	1	3	1	1	1	1	1	1	1
Calcium Hydroxide (Slaked Lime)	Ca(OH) ₂	1	1	1	1	1	1	1	1	1	1	1	1
Sodium Hydroxide (Caustic Soda)	NaOH	2	1	1	1	1	1	1	1	2	1	2	1
Calcium Hypochlor (Chlor.ted Lime)	Ca(OCl) ₂	1	1	1	1	3	1	1	1	1	1	3	1
Sodium Hypochlorite, 12.5%	NaOCl + NaCl	1	1	2	1	3	1	1	1	1	1	2	3
Potassium Permanganate, 10%	KMnO ₄	1	1	1	1	1	1	1	1	1	1	3	1
Hydrogen Peroxide, 30% (Perydrol)	H ₂ O ₂	1	1	1	1	1	3	1	1	1	2	3	1
Aluminium Sulphate	Al ₂ (SO ₄) ₃	1	1	1	1	1	1	1	1	1	1	1	1
Copper-II-Sulphate (Roman Vitriol)	CuSO ₄	1	1	1	1	1	1	1	1	1	1	1	1

Resistance rating: (1: Resistant) ; (2: Fairly resistant) ; (3: Not resistant)

Polyvinylidene fluoride (PVDF) Pump Heads, valves, fitting, tubing

Polypropylene (PP) Pump Heads, valves, fitting, level floatar

PVC Pump Heads

Stainless steel (SS 316) Pump Heads, valves

Polymethyl Metacrilate (Acrylic) PMMA Pump Heads

Hastelloy C-276 Injection valve spring

Polytetrafluoroethylene (PTFE) Diaphragm

Fluorocarbon (Viton® B) Sealings

Ethylene propylene (EPDM) Sealings

Nitrile (NBR) Sealings

Polyethylene (PE) Tubing

27. Dimensions

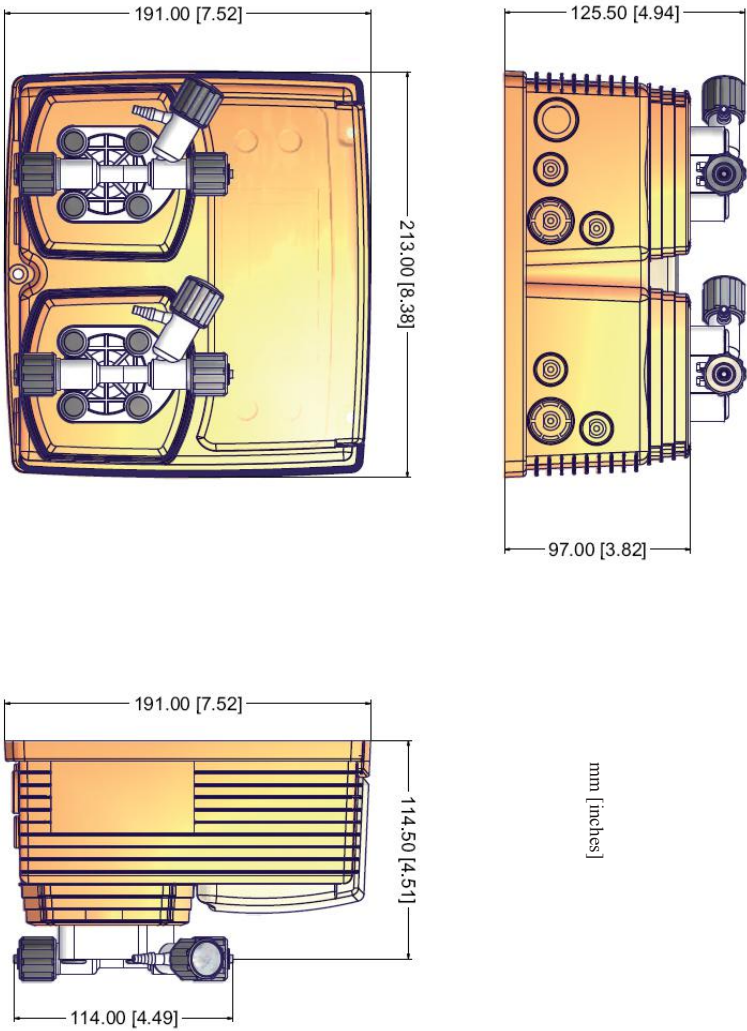

Information on this manual may contain technical inaccuracies or typographical errors.
The information contained may be changed at any time without prior notification or obligation.

28. Board connections

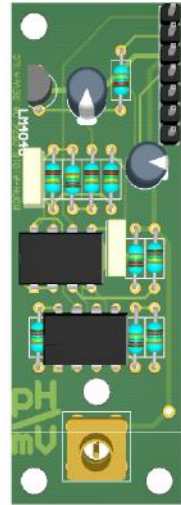
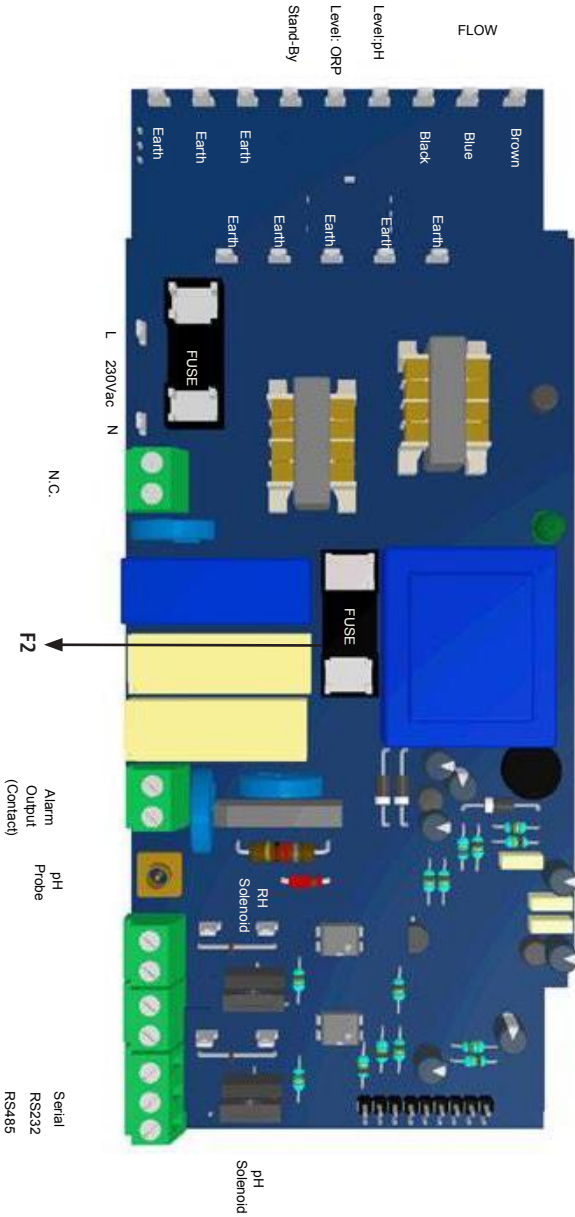

pH / ORP Probe connection module

Information on this manual may contain technical inaccuracies or typographical errors. The information contained may be changed at any time without prior notification or obligation.

28. Board connections (peristaltic version)

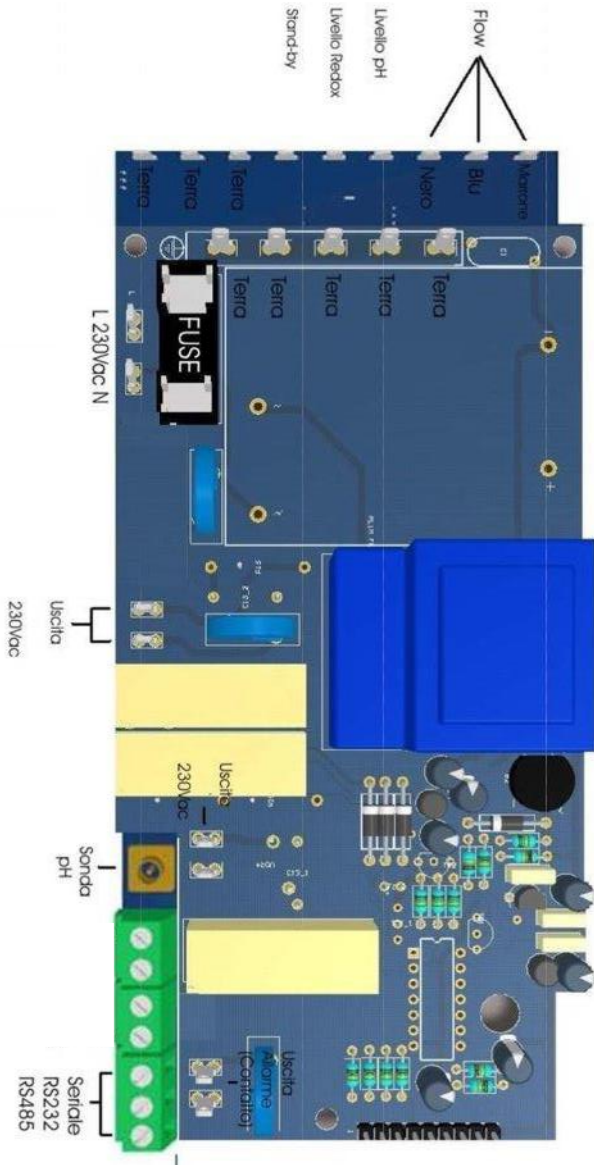

Information on this manual may contain technical inaccuracies or typographical errors.
The information contained may be changed at any time without prior notification or obligation.





Appendix - WiFi Connection

Within Communication Menu choose "WiFi" to bring wireless sub-menu. Wait until desired wireless network appears, move wheel on it then click. Otherwise click on "SCAN" to restart the search. Enter WEP / WPA / WPA2 password (if required) and wait until connection has been established and WiFi signal strength appears. To obtain a reliable connection be sure to install the controller within WiFi range. See your router features and installation procedure for best results.



WiFi signal strength

Legend:

- a. Alternating Current; 
- b. DC, 
- c. Protective Earth; 
- d. Standby; 
- e. Warning - 

Note for models without main plug only:
The unit shall be provided with a UL listed disconnect device, rated min. 250V, xxA

Appendix - WDPHTMPER

Unplug instrument from main power supply then perform connections to probes and / or selected outputs by following the below picture.

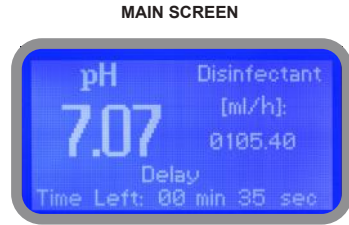
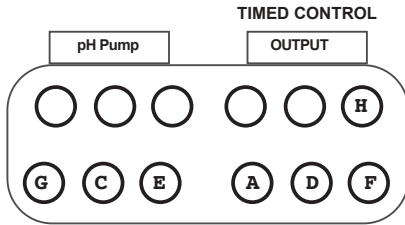

RIGHT PERISTALTIC PUMP STATUS

Time left to dosing activity for timered peristaltic pump

Warning: Connections must be performed by qualified and trained personnel only.

(A) STAND-BY input

(C) pH Level input (left pump head)

(D) ORP Level input (right pump head)

(E) pH EPHS probe connector

(G) Power Supply: 230VAC 50-60 Hz. or 115VAC or 24 VAC or VDC (see label)

(H) Alarm contact output:



- 1 n/a
- 2 Black
- 3 Red
- 4 n/a

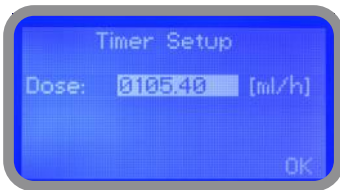

To configure the timed control options for ORP peristaltic pump, go into SETUP MENU and choose TIMER. Options are:

Dose: quantity to dose within an hour (starting at 00min 00sec).

Note: if pump can't complete the dosage due to an alarm condition it will not recover missing quantity.

If the supply cord is damaged, it shall be replaced by the manufacturer or its service agent or similarly qualified person in order to avoid a hazard.

29. Index

<i>General Safety Guidelines</i>	<i>page 2</i>
<i>Introduction</i>	<i>page 3</i>
<i>The wheel</i>	<i>page 3</i>
<i>Mainboard connections</i>	<i>page 4</i>
<i>Hydraulic connections, hoses</i>	<i>page 5</i>
<i>Hydraulic connections, level probes</i>	<i>page 6</i>
<i>Hydraulic connections, pump heads</i>	<i>page 7</i>
<i>Main screen</i>	<i>page 8</i>
<i>Quick status check</i>	<i>page 9</i>
<i>Password</i>	<i>page 10</i>
<i>“Main menu” list</i>	<i>page 11</i>
<i>“Set point” pH (ON/OFF)</i>	<i>page 12</i>
<i>“Set point” pH (Proportional)</i>	<i>page 14</i>
<i>“Set point”, ORP (ON/OFF)</i>	<i>page 15</i>
<i>“Set point”, ORP (Proportional)</i>	<i>page 16</i>
<i>“Set point”, EV (ON/OFF)</i>	<i>page 17</i>
<i>“Set point”, EV (Proportional)</i>	<i>page 18</i>
<i>“Probe Calibration”, pH</i>	<i>page 19</i>
<i>“Power Supply Calibration”</i>	<i>page 19</i>
<i>“Probe Calibration”, ORP</i>	<i>page 21</i>
<i>“Parameters”</i>	<i>page 22</i>
<i>“Pump Activities”</i>	<i>page 23</i>
<i>“Instrument Reset”</i>	<i>page 24</i>
<i>“Max Strokes settings”</i>	<i>page 24</i>
<i>“Dosnig Alarm”</i>	<i>page 25</i>
<i>“International”</i>	<i>page 26</i>
<i>“Probe Failure”</i>	<i>page 27</i>
<i>“Flow”</i>	<i>page 28</i>
<i>“Service”</i>	<i>page 28</i>
<i>“Digital Inputs”</i>	<i>page 29</i>
<i>“MODBUS”</i>	<i>page 29</i>
<i>“Log setup”</i>	<i>page 30</i>
<i>“RS485 Setup”</i>	<i>page 31</i>
<i>“SMS Menu”</i>	<i>page 31</i>
<i>“TCP/IP”</i>	<i>page 32</i>
<i>“GPRS”</i>	<i>page 33</i>
<i>“Email”</i>	<i>page 33</i>
<i>“Log View”</i>	<i>page 30</i>
<i>Technical Information</i>	<i>page 34</i>
<i>Dimensions</i>	<i>page 35</i>
<i>Board connections</i>	<i>page 36</i>
<i>WiFi</i>	<i>page 38</i>
<i>WDPHTM</i>	<i>page 39</i>



Disposal of end-of-life equipment by users

This symbol warns you not to dispose of the product with normal waste. Respect human health and the environment by giving the discarded equipment to a designated collection center for the recycling of electronic and electrical equipment. For more information visit the online site.



When dismantling a pump please separate material types and send them according to local recycling disposal requirements. We appreciate your efforts in supporting your local Recycle Environmental Program. Working together we'll form an active union to assure the world's invaluable resources are conserved.
